

IT IS HIGHLY RECOMMENDED THAT THE INSTRUCTIONS BE READ THROUGH BEFORE INSTALLATION.

**Genius**  
Retractable Screen Systems

# CASCADE

## VERTICAL PULL-DOWN RETRACTABLE WINDOW SCREEN INSTALLATION INSTRUCTIONS

SCREEN KITS USING 42mm CASSETTE

### INSTALLATION TOOLS

PHILLIPS SCREWDRIVER

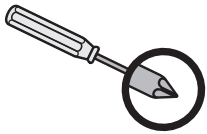

MEASURING TAPE

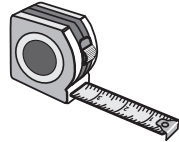

HAND-HELD OR  
POWER SAW

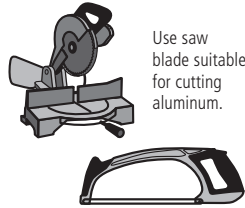

POWER DRILL & BITS

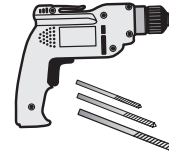

SOFT Mallet



### INSTALLATION PREP

#### 1-A Recess Installation

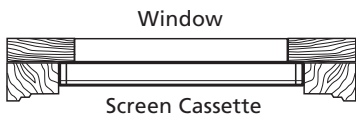
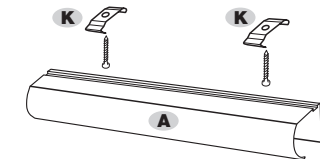

#### 1-B Surface Installation

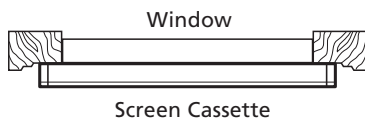
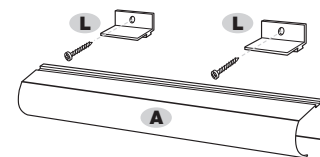

## 1 MOUNTING OPTIONS

**1-A Recess Installation :** Mount the A-Screen Cassette using K-Recess Mounting Clips inside the window frame. Recess Installations are the most common.

**1-B Surface Installation :** Surface / Flush Mount the A-Screen Cassette using L-Surface Mount Clips.

## 2 MEASURING

Measure the opening width and height in several places and record the smallest width and height measurement [2-A or 2-B]. If you have ordered a custom made screen, proceed to installation Step 8.

#### 2-A Recess Installation

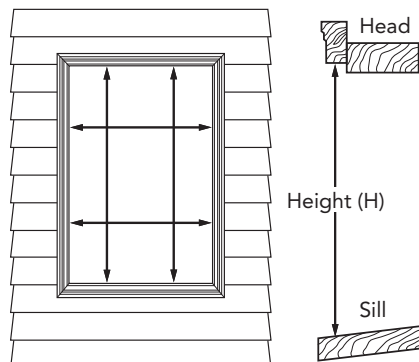
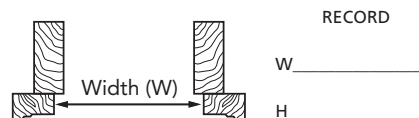

#### 2-B Surface Installation

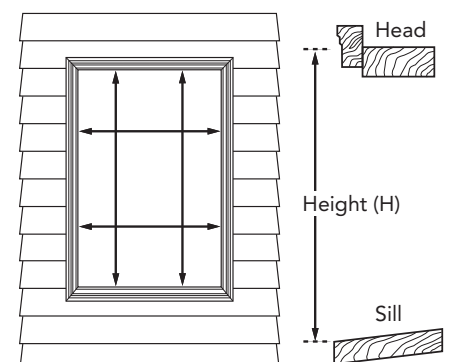
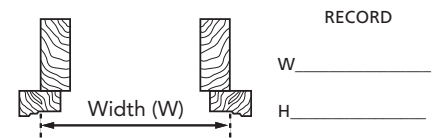

**B - SURFACE Installation**

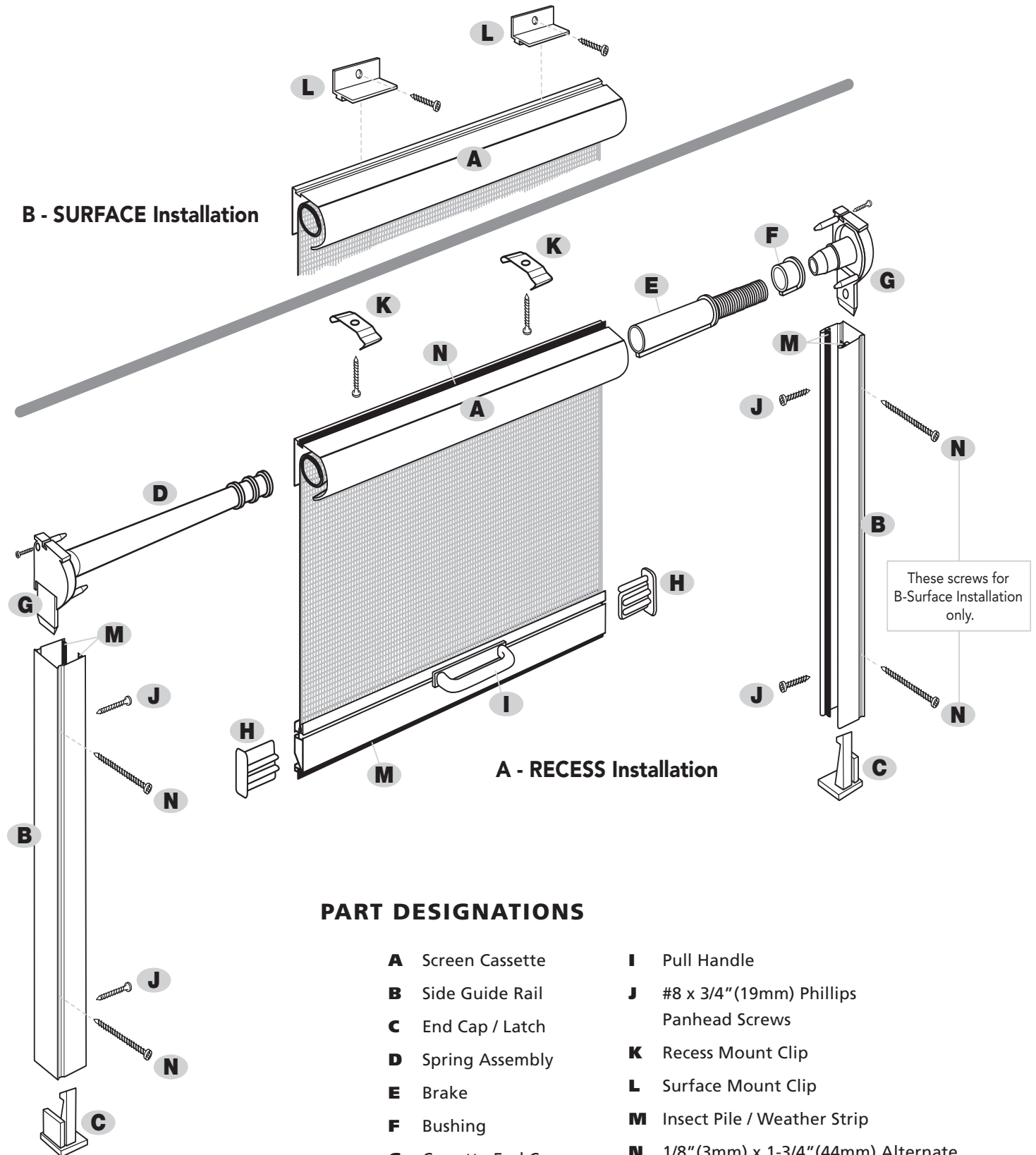

**A - RECESS Installation**

**PART DESIGNATIONS**

- |                           |   |
|---------------------------|---|
| <b>A</b> Screen Cassette  | <b>I</b> Pull Handle  |
| <b>B</b> Side Guide Rail  | <b>J</b> #8 x 3/4" (19mm) Phillips Panhead Screws                             |
| <b>C</b> End Cap / Latch  | <b>K</b> Recess Mount Clip  |
| <b>D</b> Spring Assembly  | <b>L</b> Surface Mount Clip   |
| <b>E</b> Brake            | <b>M</b> Insect Pile / Weather Strip  |
| <b>F</b> Bushing          | <b>N</b> 1/8" (3mm) x 1-3/4" (44mm) Alternate Guide Rail Surface Mount Screws |
| <b>G</b> Cassette End Cap |   |
| <b>H</b> Pull Bar End Cap |   |

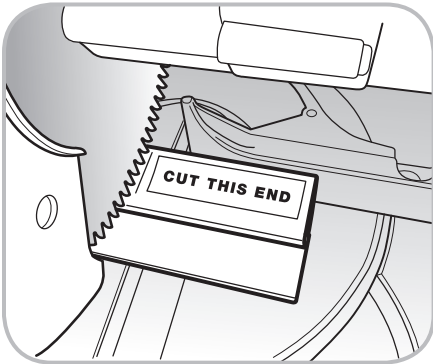

### 3 CUTTING THE CASSETTE

Notice that the **A-Screen Cassette** has two removable stickers labeled "Begin Measuring From This End" (Side A), and another labeled "Cut This End" (Side B). Starting from Side "A", mark your required dimension, then subtract 3/8" (9.5mm) from Step 2 width measurements.

$$\text{_____ (W)} - 3/8" = \text{_____}$$

The 3/8" (9.5mm) deduction is an allowance for the **G-Cassette End Cap with E-Brake** that you will install in **STEP 5**.

Firmly hold the **A-Screen Cassette & Pull Bar** and cut to size (including the screen). Hold upright and tap away the metal shavings.

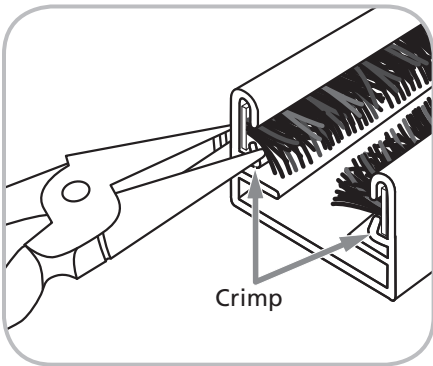

### 4 CUTTING THE SIDE GUIDE RAILS

Notice that the **B-Side Guide Rails** already have a **C-End Cap/Latch** installed at one end of the rail. **DO NOT CUT THIS END**; cut the opposite end. Mark your required net height dimension, then subtract 2-1/8" (54mm) from Step 2 width measurements. Cut the **B-Side Guide Rails** to size. Hold upright and tap away the metal shavings.

Be sure to cut the end that does not have the **G-Cassette End Cap** already installed.

$$\text{_____ (H)} - 2-1/8" = \text{_____}$$

After cutting the **B-Side Guide Rails**, use pliers to crimp the **M-Insect Pile/Weather Strip** in place [see picture at left] so that it does not move in the holding channels.

### 5 INSECT PILE / WEATHER STRIP

**Recess Mount Applications :** The **M-Insect Pile/Weather Strip** is already installed in the channel located on the rear of the Cassette.

**Surface Mount Applications :** Remove the **M-Insect Pile/Weatherstrip** from the channel at the top back of the **A-Screen Cassette**. Then slide the runners on the bottom of two (2) **L-Surface Mount Clips** into the same channel, **BEFORE** installing **G-End Caps**. Note: the position of the **L-Surface Mount Clips** can be adjusted at any time once installed in the channel.

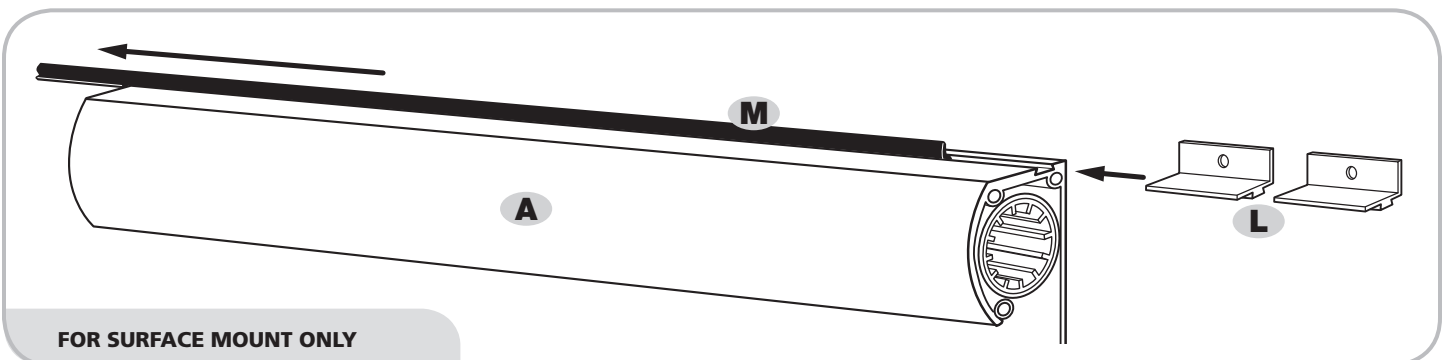

## 6 END CAP ASSEMBLY CONT.

The E-Brake, F-Bushing and G-Cassette End Cap come pre-assembled.

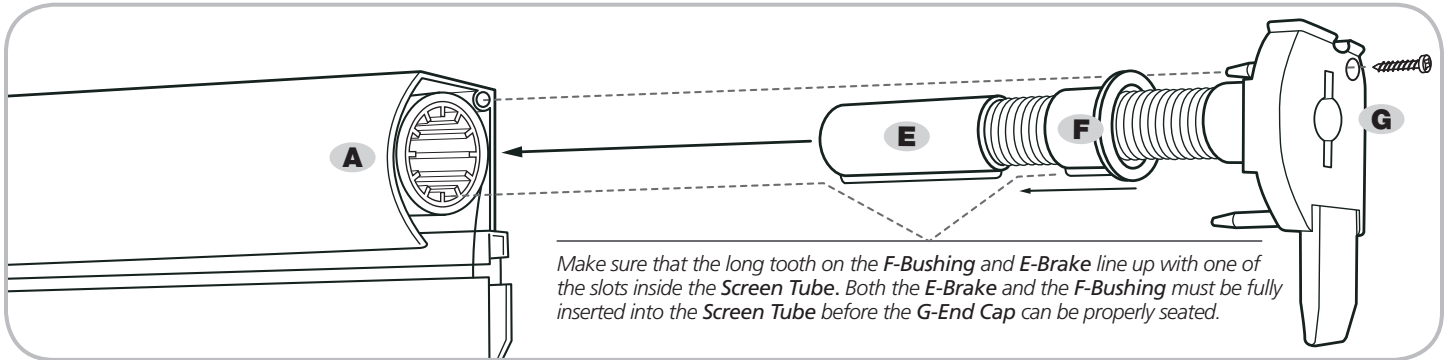

Slip the F-Bushing down the coiled spring to the E-Brake. On the open end of the A-Screen Cassette, insert the E-Brake with F-Bushing into the center of the Screen Tube, aligning the long tooth on both as noted above. Next, match up the large pin on the top of the G-End Cap to the corresponding hole at the top of the A-Screen Cassette Housing. Tap evenly with a soft mallet until the assembly fits snugly.

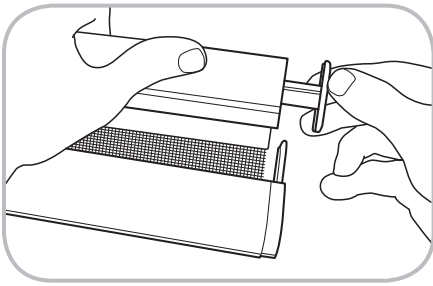

## 7 PULL BAR END CAP

Insert the H-Pull Bar End Cap into the end of the Pull Bar and tap in place using a soft mallet.

## 8 HANDLE ASSEMBLY

**Step 1:** Cut out template and position onto the pull rail at desired location. Use tape to hold in place.

**Step 2:** Drill two 3/16" holes all the way through the pull rail.

**Step 3:** Attach the handle using (2) #8-32 x 1/2" Phillips Pan Head screws.

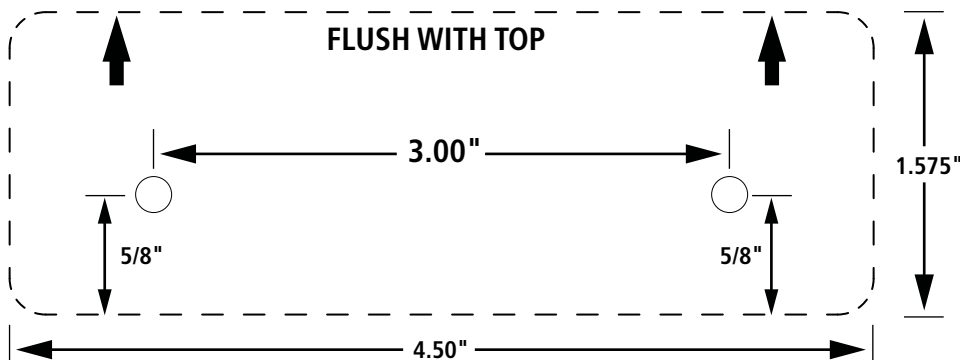
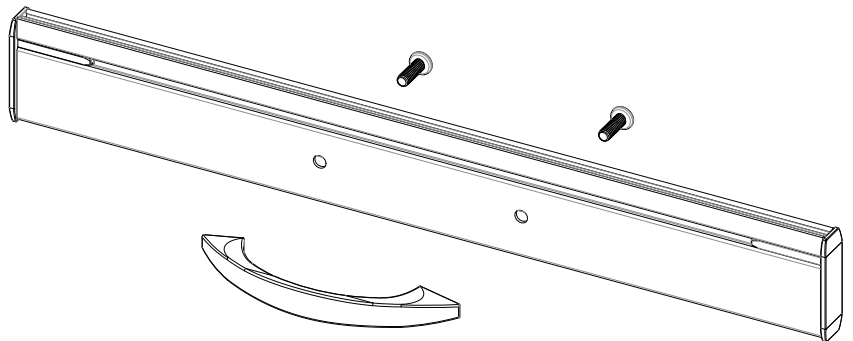

**INSTALLATION**

**8-A Recess Installation**

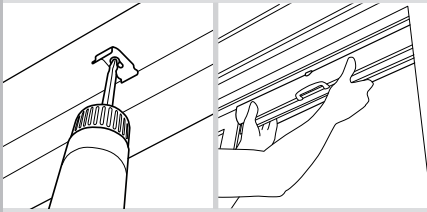

**8-B Surface Installation**

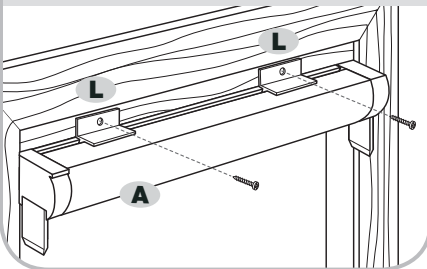

**NOTE:** It is critical that the Screen Cassette and Rails be installed square and plumb in the door opening. Apply shims (not supplied) as needed.

**8** INSTALLING THE CASSETTE

**8-A Recess Installation :** Use J-#8 x 3/4" (19mm) Phillips Panhead Screws to install K-Recess Mount Clips to the door frame approx. 4" in from each side. Snap only the A-Screen Cassette into the Mount Clips.

**8-B Surface Installation :** Position the A-Screen Cassette, insert J-#8 x 3/4" (19mm) Phillips Panhead Screws into L-Surface Mount Clips and secure A-Screen Cassette to the frame.

**9 End Cap/Latch Position**

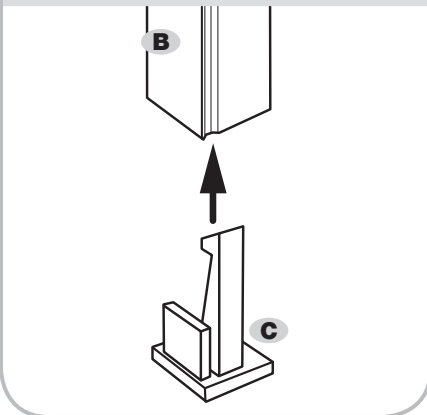

**9** INSTALL THE SIDE RAILS

Before installing the two B-Side Guide Rails, rotate them so that the decorative groove on the rail and the C-End Cap / Latches are positioned as shown in [9]. The C-End Cap / Latch must be positioned in this manner in order for the 'hook' of the latch to correctly engage the A-Screen Cassette Pull Bar when the screen is extended.

**9-A Recess Installation :** Insert both B-Side Guide Rails onto the protruding tabs of the G-Cassette End Caps [9-A.1].

Align the B-Side Guide Rails into the final position. Drill 3/16" (5mm) pilot holes at 3" (76mm) in from either end and in the center in between. Attach the B-Side Guide Rail to the door frame using J-#8 x 3/4" (19mm) Phillips Panhead Screws. When installing the B-Side Guide Rail, use the Black Plastic Pile Opener Tool that is provided with the screen kit to move the M-Insect Pile/Weather Strip out of the way while screwing the rails to the frame [9-A.2].

**9-A.1 Side Rail to Cassette End Cap**

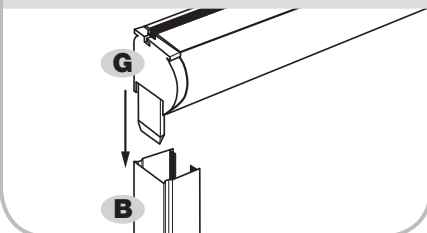

**9-B Surface Installation :** Using the decorative trim groove as a guide (and staying to the outside of the glide platforms inside the rail), drill 1/8" (3mm) holes through both sides of the B-Side Guide Rail. Begin by drilling holes approximately 3" (8cm) in from each end and then evenly space additional holes about every 12" (30cm). Secure the Guide Rail to the window with N-1/8" (3mm) x 1-3/4" (44mm) Alternate Guide Rail Surface Mount Screws provided in the bag labeled Surface Mount Kit. Do not over tighten screws.

**9-A.2 Recess Install**

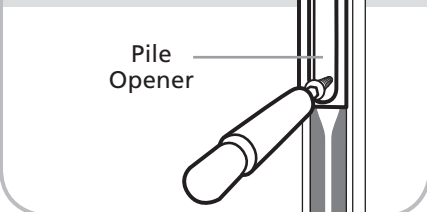

**9-B Surface Install**

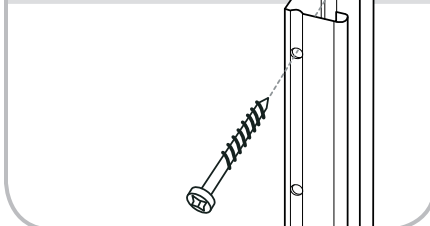

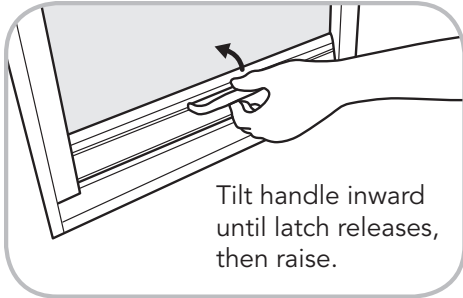

### OPERATION OF THE SCREEN

The internal lock mechanism will automatically catch once the rollerscreen is fully extended. To retract the screen, nudge the I-Pull Handle inwards slightly to release the lock.

**WARNING:** Please use eye protection when cutting and installing your screen. This is not a safety or security screen. This product will not stop a child or pet from falling, provide security or protect your belongings.

## TROUBLESHOOTING GUIDE

### **RETRACTABLE SCREEN IS DIFFICULT TO PULL OR BOUNCES AS IT OPENS AND CLOSSES:**

- ▶ Check **B-Side Guide Rails** for screws that are not flush to the side housing. A lopsided screw head could interfere with screen action.
- ▶ Clean any debris from inside the **B-Side Guide Rails**.
- ▶ Make sure **A-Screen Cassette** has a 90° cut. If not, trim to a straight cut.
- ▶ A bouncing effect may indicate that the **F-Bushing** is not properly inserted inside the Screen Tube.
- ▶ Check if **A-Pull Bar** is rubbing against the **B-Side Guide Rails**. Trim down accordingly.
- ▶ Check to see that the **H-Pull Bar End Cap** is gliding freely.

### **THE RETRACTABLE SCREEN BINDS OR WILL NOT RETRACT INTO THE CASSETTE HOUSING PROPERLY:**

- ▶ See above steps.
- ▶ Make sure screen fabric is cut clean. A jagged cut will interfere with screen action.
- ▶ Check to see if the housing or inner tube have been twisted, bent or otherwise damaged during shipping.

### **SCREEN HAS BECOME TORN OR DAMAGED:**

- ▶ Replace the mesh using a Screen Refill Replacement Kit.